

Varenummer: 0125087  
 Beskrivelse: Seeger låsering SP80  
 Fjederstål

## Mål

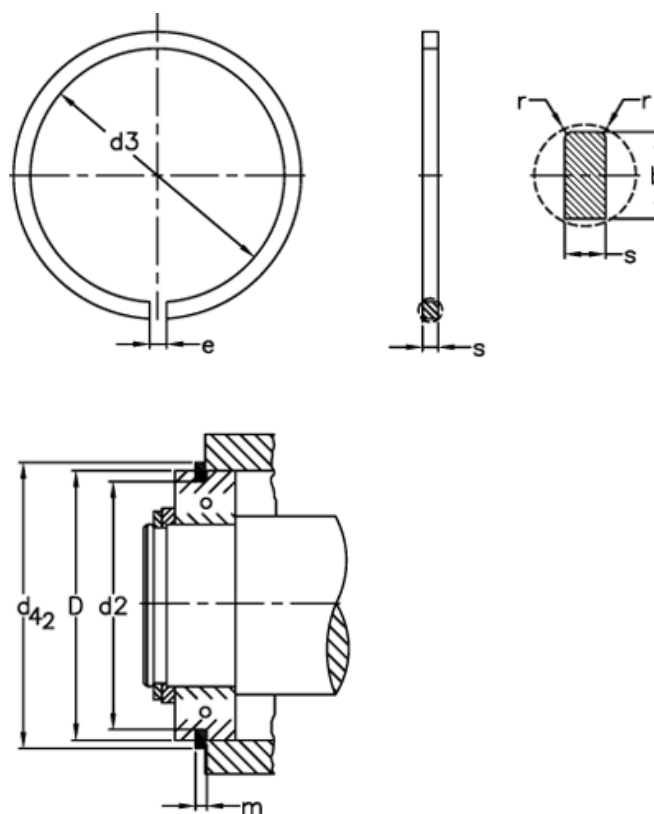

b	= 4.85	FRg kN	= 5.25	tol	= -0.15
Betegnelse	= SP 80	FR kN	= 34.8	tol	= -0.1
D	= 80	g	= 3.0	tol	= -0.50
d2	= 76.81	K kN-mm	= 64.0	tol	= 0.3
d3	= 75.4	m	= 1.90	tol	= 0.8
d42	= 86.6	n abl x 1000	= 3.0	vægt kg/1000	= 16.3
e	= 5	r min	= 0.6		
FN kN	= 65.7	s	= 1.70		